

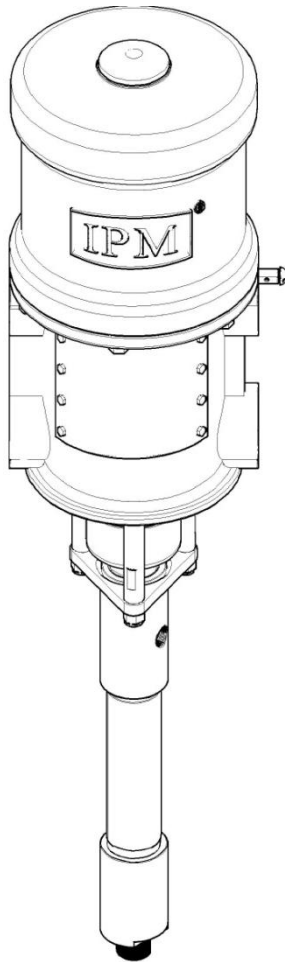

IP-30
30:1 RATIO TRANSFER PUMP
OPERATIONS MANUAL



IPM, INC.

Manufactured by International Pump Manufacturing, Inc. ®

IP-30

30:1 RATIO TRANSFER PUMP

OPERATIONS MANUAL
with
PARTS IDENTIFICATION

INTERNATIONAL PUMP MANUFACTURING, INC.

3107 142nd Ave. E., Suite 106
Sumner, WA 98390
Ph: 253-863-2222
Fax: 253-863-2223.

WARNING

THE EQUIPMENT DESCRIBED HEREIN MUST ONLY BE OPERATED OR SERVICED BY PROPERLY TRAINED INDIVIDUALS, THOROUGHLY FAMILIAR WITH THE OPERATING INSTRUCTIONS AND LIMITATIONS OF THE EQUIPMENT.

TABLE OF CONTENTS

1.0	SAFETY WARNINGS.....	4
2.0	INSTALLATION.....	7
2.1	Mounting configurations.....	8
3.0	OPERATIONS.....	9
	.	
4.0	TROUBLESHOOTING.....	10
5.0	PARTS IDENTIFICATION.....	11
6.0	TECHNICAL SPECIFICATIONS.....	14
7.0	WARRANTY & DISCLAIMER.....	16

1.0 SAFETY WARNINGS

Please read and observe all warnings contained in this operations manual before any attempt to operate the equipment.

Misuse of Equipment

Misuse of the Equipment can cause serious injury. Use the equipment only for its intended purpose. Care should be taken to prevent over pressurization of the pump or accessories connected to it. Use only proper parts in good condition. Use the pump only with compatible fluids. Improper use or misuse of this equipment could result in fluid being splashed on the skin or in the eyes, serious bodily injury, property damage, fire or explosion.

Make daily check on the equipment and repair damaged or worn parts immediately.

Do not alter this equipment, doing so could cause it to function incorrectly and could cause serious injury.

MATERIALS AND FLUID COMPATIBILITY

Always ensure the chemical compatibility of the fluids and solvents with the wetted parts in the pump and any components. Check the fluid manufacturer's data sheets and specifications before using the fluids or solvents in this pump.

PRESSURIZED HOSES

Because the hoses are pressurized, they present a danger should the fluid escape at high pressure. This escaping fluid pressure can spray out and cause serious bodily injury or property damage. Ensure that the hoses do not leak or rupture due to wear, misuse or damage.

The hoses should be handled properly - do not pull on the hoses to move the equipment around. Use the hoses only for fluids in which they are compatible both for the inner liner of the hose and the outer covering. Use care not to exceed the temperature rating of the hose.

Before each use, ensure that the fluid couplings are tight and that the entire length of hose is not worn or damaged. Check the entire hose for leaks, bulging cover, damage, abrasion or cuts. These conditions may cause the hose to fail which could result in splashing of pressurized fluid on the skin, or in the eyes and cause serious bodily injury or property damage.

PRESSURE SPECIFICATIONS

The Maximum Working Pressure of this equipment is 3600 psi at a Maximum Incoming Air Pressure of 120 psi (8 bar). Ensure that all equipment and accessories used with this pump are rated to withstand the maximum working pressure of this pump. NEVER exceed the maximum working pressure of the pump or any device attached to the pump.

Procedure for Pressure Relief

In order to avoid the risk of serious bodily injury such as splashing fluid on the skin or in the eyes, or risk of injury from moving parts, the following procedure should be used. This procedure should be used when shutting down the pump, when servicing or repairing the pump or any part of the system, when replacing or cleaning components, or when pumping of fluid is stopped.

1. Close the air valve to the pump.
2. Use the air bleed down valve (see installation instructions) to relieve the air pressure in the system.
3. Relieve the fluid pressure by holding a grounded metal pail in contact with the metal part of the fluid dispense valve and slowly opening the valve.
4. With a container ready to catch the fluid open the drain valve (see installation instructions).
5. It is a good practice to leave the drain valve open until it is time to dispense fluid again.

If you are unsure that the fluid pressure has been relieved (due to a blockage in a component or a hose) be careful to relieve the pressure by slowly loosening the hose end coupling to allow the fluid pressure to escape slowly. After the pressure has been relieved, the fitting can be removed completely and any blockages removed.

Hazards from Fire or Explosion

Hazards exist when sparks can ignite vapors or fumes from flammable or combustible materials or other hazardous conditions (explosive dusts, etc.). These sparks can be created from plugging in or unplugging an electrical supply cord. Sparks can also be created from the static electricity generated by the flow of fluid through the pump and hose.

Every part of the equipment must be properly grounded to prevent static electricity from generating a spark and causing the pump or system to become hazardous. These sparks can cause a fire, explosion, and serious bodily injury and property damage. Ensure that the pump and all components and accessories are properly grounded and that electrical supply cords are not plugged in or unplugged when these hazards exist.

Should any evidence of static electricity (sparks or small shocks while in contact with the equipment) exists, discontinue the operation immediately. Investigate the source of the static electricity and correct the grounding problem. Do not use the system until the grounding problem is repaired.

GROUNDING PROCEDURES

Grounding of the pump and all other dispensing equipment is necessary to minimize the possibility of sparks due to static electricity. Grounding must be in compliance with local electrical codes. Check with the local authorities for requirements in your area and with the type of equipment being used. Ensure that all the following equipment is grounded:

1. Air Compressor: Follow the grounding procedures as recommended by the manufacturer.
2. Air Hoses: Use grounded air hoses.
3. Fluid Container used to supply the system: Grounding must be done according to local codes.
4. Pump: Follow the procedures included referring to Figure 1.
5. Fluid Hoses: Use grounded fluid hoses.
6. Dispensing Valve: The valve must be metal to conduct through the fluid hose to the pump which must be properly grounded.
7. Dispensing Point: Grounding must be done according to local codes.
8. Solvent Containers: Grounding must be done according to local codes. Use metal conductive pails that are properly grounded.
9. Grounding while dispensing, cleaning, or relieving: Maintain conductivity by firmly holding the metal part of the dispensing valve to the side of a grounded metal container.

FIGURE 1

GROUNDING THE PUMP:

Follow these procedures for grounding the pump. Loosen the lock screw (W) to allow insertion of one end of a 12 ga. (1.5 mm²) minimum size wire into the hole in the side of the lug (Z). Insert the wire (Y) and tighten the lock screw securely. The other end of the ground wire must be secured to a true earth ground.

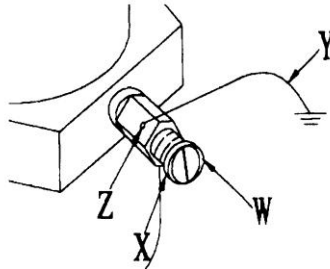

HOSE GROUNDING: It is very important that the hoses used for both air and the fluid be a grounding type and that this ground continuity is maintained. Regular checks of the hose ground resistance (with a resistance meter using a suitable range) and a comparison to the Manufacturer's Specification will ensure the ground is within specifications. If it is not within specified limits it should be replaced immediately.

SOLVENT CLEANING: While cleaning the system with solvent, hold the metal part of the dispensing valve in contact with a grounded metal pail to minimize the possibility of splashing fluid on the skin or in the eyes or static sparks. Use low fluid pressure for additional safety.

HAZARDS FROM MOVING PARTS: Use the Pressure Relief Procedure to prevent the pump from starting unintentionally when not desired. Take care that moving parts present a pinching hazard to fingers or other body parts. Stay clear of these moving parts when starting or operating the pump.

SAFETY STANDARDS: Safety standards have been established by the United States Government under the Occupational Safety and Health Act. These standards should be consulted as they apply to the hazards and type of equipment being used.

2.0 INSTALLATION

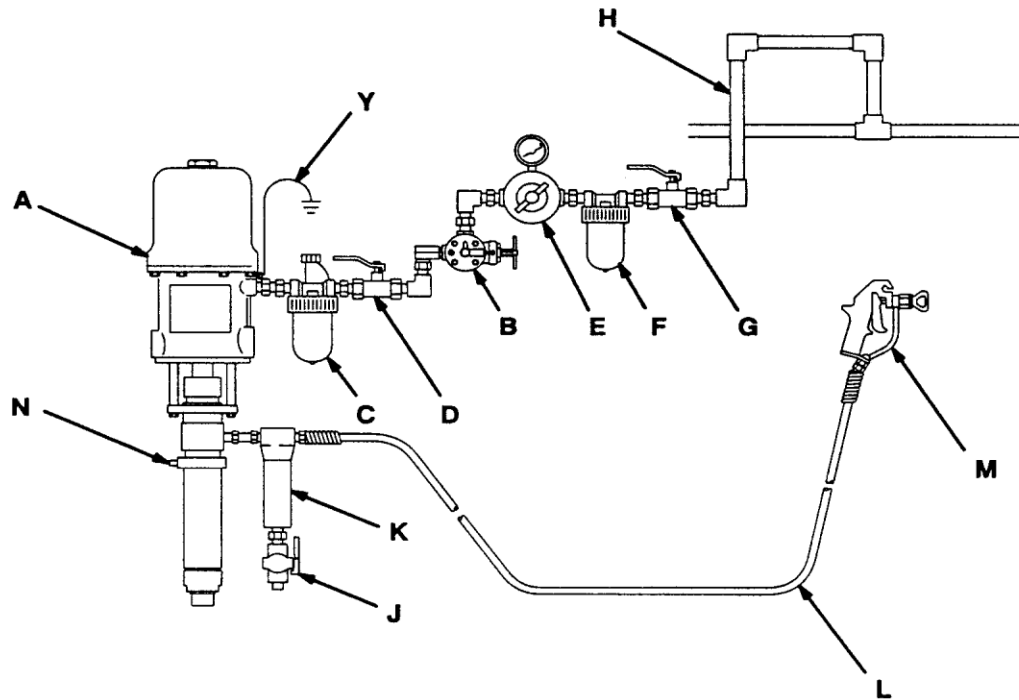

KEY

A	Pump
B	Pump Runaway Valve
C	Air Line Lubricator
D	Bleed-Type Master Air Valve (required, for pump)
E	Pump Air Regulator
F	Air Line Filter
G	Bleed-Type Master Air Valve (for accessories)
H	Air Supply Hose
J	Fluid Drain Valve (required)
K	Fluid Filter
L	Fluid Supply Hose
M	Spray Gun
N	Pump Bung Adapter
Y	Ground Wire (required; see page 3 for installation instructions)

FIGURE 2

Figure 2 depicts a typical installation provided as a guide for your reference. Select and install optional accessories required. Feel free to call **IPM** representative or **IPM** Technical Department for assistance.

2.1 Mounting Configuration

Install the necessary accessories in sequence using figure 2 as a guide. An Air Regulator (E) for metering of air flow is required with the equipment. To minimize the risk of serious bodily injury such as splashing fluid on the skin or in the eyes; or risk of injury from moving parts, install the following accessories in your system.

1. Bleed-off master air valve (D). This valve will relieve the air trapped within the system after the pump is stopped. Air that is trapped between this valve and the pump can cause the pump to reciprocate unintentionally which may cause harm to the operator.
2. Fluid Drain Valve (J). The fluid drain valve (use a metal valve for grounding purposes) is installed to relieve fluid pressure in the pump, hose or the dispensing valve when the pump is stopped. The relief of pressure by the dispensing valve, which at times is inadequate if there is a clog or restricted passage in the hose or the dispensing valve, can be achieved by using this fluid drain valve (J).
3. Low level cut-off valve or runaway safety valve. The low level cut-off valve should be installed at the fluid intake of the pump. It shut off the fluid intake when the fluid level is too low., hence causing the pump to stall. This is to prevent the pump from running empty. If not, then a runaway safety valve should be installed. This valve shut off the air supply to the pump if the pump accelerates beyond the pre-set value when the fluid level is too low and the pump pumping empty or insufficient fluid for normal pump functioning.

Connect an air lubricator (C) ahead of the regulator (E). The lubricator provides proper lubrication to the air motor. (see daily maintenance check). Next, install a bleed-off master air valve (G). This valve is required in your system to relieve trapped air (as explained above).

Air Filter (F) helps to remove dirt and foreign particles from the supply air, water moisture also will be trapped within this filter. Be sure to release the trapped water daily as a good housekeeping practice (also see daily maintenance check). Connect a grounded air supply hose to supply to the pump's 1/2npt(f) air inlet(K).

For the fluid section, connect one fluid drain valve (J) directly after the outlet of the pump. Be sure to connect it pointing downwards for safety. Connect a grounded fluid hose(H) to the fluid outlet (M) 3/8" npt(f).

Grounding of the pump and accessories are to be ensured before operation. Observe all OSHA regulations and other safety regulations.

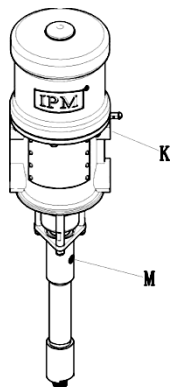

3.0 Operation

Procedure for Pressure Relief

In order to avoid the risk of serious bodily injury such as splashing fluid on the skin or in the eyes, or risk of injury from moving parts, the following procedure should be used. This procedure should be used when shutting down the pump, when servicing or repairing the pump or any part of the system, when replacing or cleaning components, or when pumping of fluid is stopped.

1. Close the air valve to the pump.
2. Use the air bleed down valve (see installation instructions) to relieve the air pressure in the system.
3. Relieve the fluid pressure by holding a grounded metal pail in contact with the metal part of the fluid dispense valve and slowly opening the valve.
4. With a container ready to catch the fluid open the drain valve (see installation instructions).
5. It is a good practice to leave the drain valve open until it is time to dispense fluid again.

If you are unsure that the fluid pressure has been relieved (due to a blockage in a component or a hose) be careful to relieve the pressure by slowly loosening the hose end coupling to allow the fluid pressure to escape slowly. After the pressure has been relieved, the fitting can be removed completely and any blockages removed.

Start up and Adjustment of the Pump

Ensure that installation is fully completed before proceeding to start up operations.

1. Ensure that the air regulator (E) is closed. Open the bleed-type master air valves (D). Connect the quick disconnect coupler to the male fitting.
2. Into a grounded metal container, open the dispensing valve (J) slowly. Ensure metal-to-metal contact between the container and the valve.
3. Adjust the pump air regulator (E) slowly for pressure just enough to start running the pump. This is to prime all air within the system. After all the air has been expelled from the lines, close the dispensing valve. During the priming of the pump, the pump runs when the dispensing valve is opened and stop when the valve is closed.
4. Turn the air regulator slowly until sufficient flow from the dispensing valve is achieved. Remember to run the pump always at the lowest possible speed necessary to achieve what is desired. Never exceed the maximum working pressure of any component in the system.
5. The pump should not be left to run dry of the fluid being worked upon. When running empty, the speed will become very quickly and probably damaging itself. During operation, should the pump be found to run too fast, stop it immediately and check the fluid supply. Is the fluid level in the drum too low or empty? If air has gone into the system, do a priming procedure. Ensure that all air has been expelled from the lines before operation again. Flush the pump or leave it filled with a compatible solvent when not in use.
6. Always follow the Pressure Relief Procedure should the pump be put away for any period of time or during system shut off at the end of the day.

Daily Maintenance Check

1. Ensure sufficient lubricant in the air lubricator.
2. Drain the moisture trapped in the air pressure regulator.

Clean and flush the pump thoroughly with care and appropriate cleaning fluid to obtain maximum service life of the equipment.

4.0 Troubleshooting

Problem	Causes	Recommended Solutions
Pump does not operate.	<p>Air supply or pressure is inadequate. Air lines restricted.</p> <p>Dispensing valve is not open or clogged. Clogged fluid lines, valves, hoses, etc Damaged air motor.</p> <p>Depleted or exhausted fluid supply.</p>	<p>Increase air pressure. Check for any restrictions in air line.</p> <p>Open and/or clear valve.</p> <p>Follow pressure relief procedure to clear obstruction. Service air motor. Replace parts as necessary. Refill fluid. Prime system or flush it.</p>
Non-stop air exhaust.	Worn or damaged air motor gasket, packing, seal, etc	Service air motor. Replace parts as necessary.
Erratic pump operation.	<p>Intake valve or packings worn off.</p> <p>Intake valve is not completely closed.</p>	<p>Refill fluid. Prime system or flush it.</p> <p>Clear obstruction and service pump. Replace parts as necessary.</p>
Low output on upstroke.	Held open or worn intake valve.	<p>Clear obstruction and service pump.</p> <p>Replace parts as necessary.</p>
Low output on down stroke.	Held open or worn intake valve.	<p>Clear obstruction and service pump.</p> <p>Replace parts as necessary.</p>
Low output on both strokes.	<p>Restriction in air lines or air pressure low. Closed or clogged valves.</p> <p>Fluid supply is insufficient or exhausted.</p> <p>Obstructions in fluid lines, hoses, valves, etc.</p>	<p>Increase air pressure or supply.</p> <p>Open valve or clear valve.</p> <p>Refill fluid. Prime system or flush it.</p> <p>Follow pressure relief procedure to clear obstruction.</p>

5.0 Parts Identification

5.1 Part List for AIR MOTOR Section

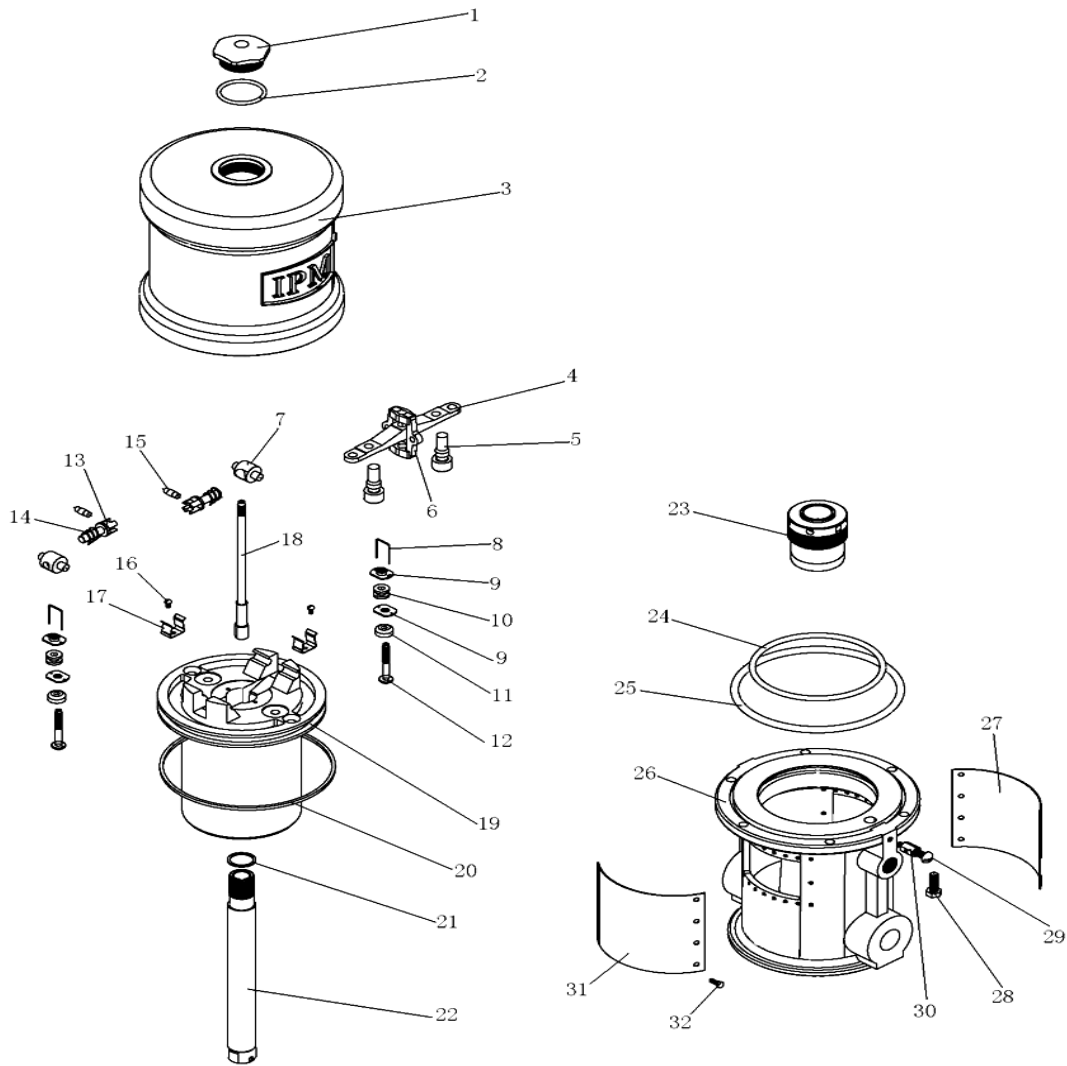

REF NO	Part No	Description	QTY
1	500300	Nut,cap	1
2	500206	O-Ring	1
3	500404	Air Cylinder	1
4	500405	Actuator, valve	1
5	500304*	Poppet, valve	2
6	500312	Yoke,rod ,trip	1
7	500313	Rocker,toggle	2
8	500307*	Lockingwire	2

REF NO	Part No	Description	QTY
18	500406	Rod trip	1
19	500408	Piston Assy	1
20	500409*	O-Ring	1
21	500410	Gasket,copper	1
22	500411	Rod,piston	1
23	700032	Bearing housing Assy	1
24	500414*	O-Ring	1
25	500415	O-Ring	1

9	500309*	Nut,adjusting	4
10	500308*	Grommet	2
11	500311*	Poppet,valve	2
12	500310*	Stem,valve	2
13	500314	Arm,toggle	2
14	500315	Spring	2
15	500316	Pin,toggle	2
16	500305	Screw	2
17	500407	Clip,spring	2

26	500416	Base	1
27	500489	Plate,Identification	1
28	500322	Screw Hex head	8
29	500108	Screw	1
30	500107	Lug,grounding	1
31	500490	Plate,warning	1
32	500325	Screw Hex head	20
33	601001	Repair Kit**	1

5.2 Part list for Fluid Section

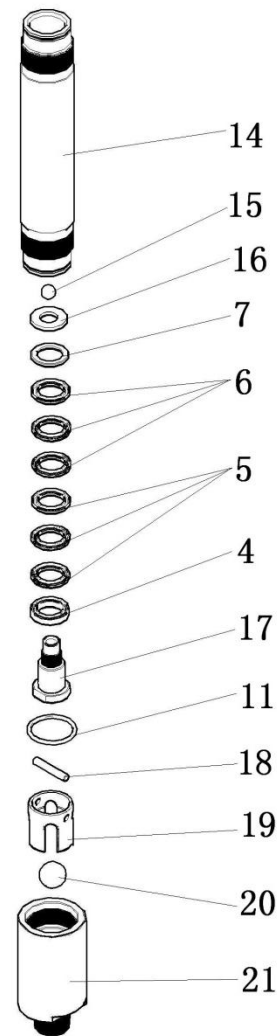
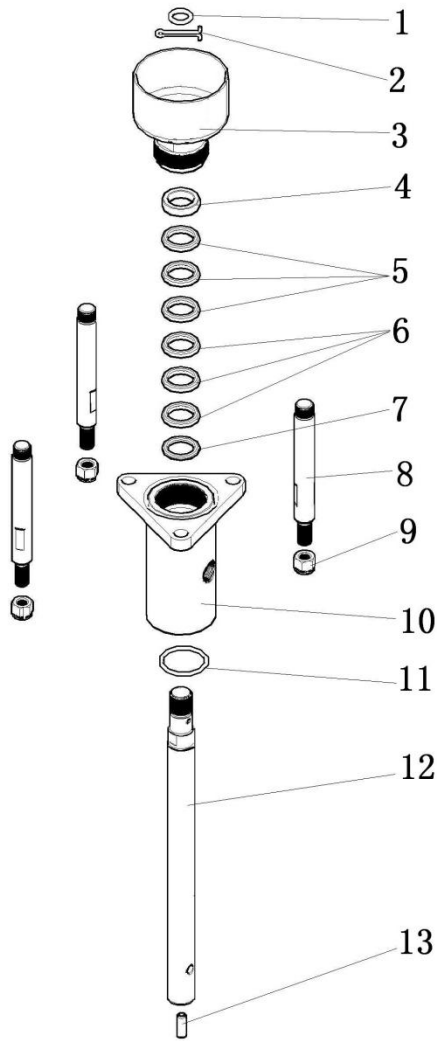

REF NO	Part No	Description	QTY
1	500402	O-Ring	1
2	500449	Pin,cotter	1
3	700065	Nut,packing	1
4	501006	Gland,female	2
5	501007	V-packing.thraot	6
6	501008	V-packing.thraot	6
7	501009	Gland,male	2
8	501001	Tie rod	3
9	500448	Nut,lock	3
10	700066	Housing,outlet	1
11	500807	O-Ring	2

REF NO	Part No	Description	QTY
12	500804	Main Shaft	1
13	500708	Pin	1
14	500819	Cylinder	1
15	500813	Ball	1
16	501004	Washer,piston	1
17	501005	Piston Valve Housing	1
18	500821	Pin,ball stop	1
19	500820	Guide,ball,intake	1
20	500068	Ball	1
21	500802	Housing valve	1

6.0 Technical Specifications

(A) Recommended Application Chart

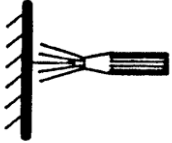
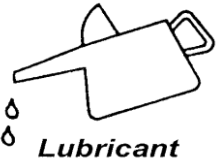
Industry	Application	Viscosity Range(CPS)
 Chemical	Alcohol	0-100
	Dye	0-1000
	Methyl Chloride	0-200
	Solvents	0-500
 Surface Finishing Material	Paint(Latex)	100-1000
	Paint(Oil base)	100-800
	Sealer(Wood)	100-800
	Stain(Oil base)	100-1000
 Lubricant	Anti-Freeze	30-100
	Die Lubricant	30-50
	Gear Oil	200-1000
	Lubricant	100-1500
	Mold Release Agent	30-100
	Oil	100-500

(B) Technical Specifications

PRESSURE RATIO	30 : 1
MAXIMUM CONTINUOUS FLOW	0.98 gpm
MAXIMUM FLUID PRESSURE	3600 psi
AIR INPUT PRESSURE RANGE	30 – 120 psi (2 – 8 bar)
AIR INLET SIZE	1/2" npt(f)
FLUID INLET SIZE	3/4" npt(m)
FLUID OUTLET SIZE	3/8" npt(f)
WEIGHT	14.6 kg

(C) Pump Dimensions

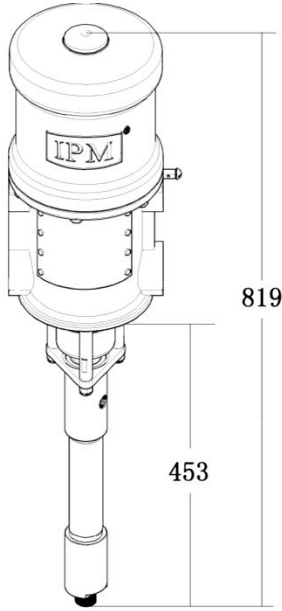

(D) Performance

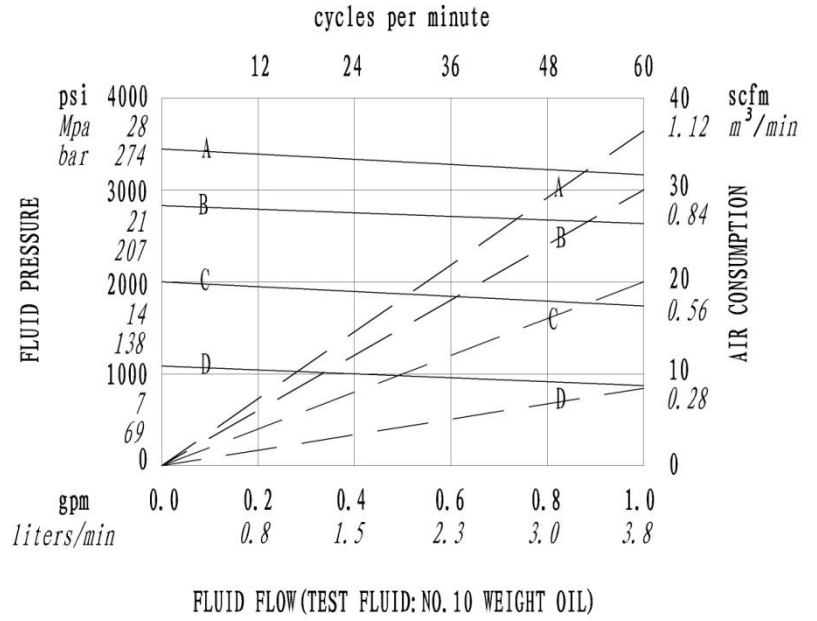

- A** 120 psi (0.8Mpa,8 bar) air pressure
- B** 100 psi (0.7Mpa,7 bar) air pressure
- C** 70 psi (0.49Mpa,4.9 bar) air pressure
- D** 40 psi (0.28Mpa,2.8 bar) air pressure

How to Read Performance

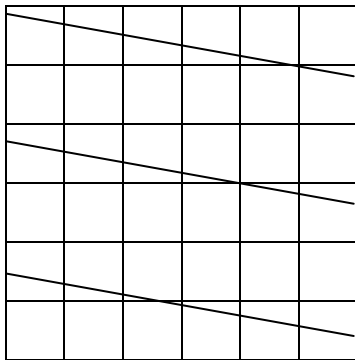

Pressure/Flow

1. Locate required flow along bottom edge of chart.
2. Follow vertically to bold line for input air pressure.
3. Follow horizontally to left edge of chart to read maximum available fluid pressure.

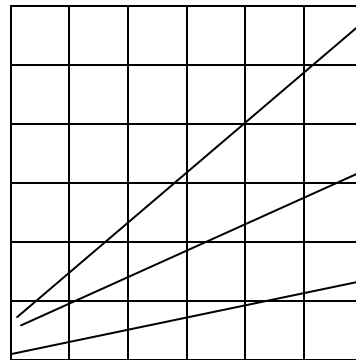

Air Consumption

1. Locate fluid flow along bottom edge of chart.
2. Follow vertically to bold line for input air pressure.
3. Follow horizontally to right edge of chart to read air consumption.

7.0 Warranty and Disclaimer

WARRANTY

International Pump Manufacturing, Inc. (**IPM**) warrants the equipment it manufactures to be free of defects in material and workmanship for a period of one year from the day of sale by an authorized **IPM** distributor to the original purchaser. **IPM** will at its discretion repair or replace any part of the equipment proven to be defective. This warranty applies only when the equipment is used for the intended purpose and has been installed, operated and maintained in accordance with the written recommendations.

A condition of the warranty is the prepaid return of the equipment to an authorized distributor of **IPM** who shall provide verification of the warranty claim. **IPM** will repair or replace, free of charge any parts found and verified to be defective. Transportation will be prepaid for the repaired or replaced parts under warranty. Should the inspection of the equipment not reveal any defect in material or workmanship, repairs will be made at standard charges which include parts, labor and transportation.

The warranty does not apply to nor will **IPM** be liable for damage, wear, or malfunction of equipment caused by improper installation, misuse, abrasion, corrosion, negligence, accident, tampering, lack of improper maintenance, or by substitution of non-**IPM** parts. Additionally **IPM** shall not be liable for and the warranty does not apply to wear, damage, or malfunction caused by incompatibility of accessories, components, structures, equipment or materials not supplied by **IPM**. The warranty does not apply to nor will **IPM** be responsible for the improper operation, maintenance, design, manufacture, installation of components, accessories, equipment or structures not supplied by **IPM**.

The warranty is void unless the Warranty Registration Card is properly completed and returned to International Pump, Inc. within ONE month of the date of the sale.

LIMITATIONS AND DISCLAIMERS

This warranty is the sole and exclusive remedy for the purchaser. No other warranties (expressed or implied), including warranties for fitness of purpose or merchantability, or non-contractual liabilities are made, including product liability, whether on negligence or strict liability basis. Liability for directly special or non-contractual damages or loss is expressly excluded and denied. **IPM's** liability shall in no case exceed the amount of the purchase price.

IPM does not warrant and disclaims implied warranties of merchantability and fitness for a particular purpose, components, accessories, equipment, materials sold but not manufactured by **IPM**. These items (switches, hoses, etc.) are subject to the provisions of the warranty of the manufacturer of these items. **IPM** will provide reasonable assistance with warranty claims on these items.